

Power Module for 0.75 hp Motor Drives

- 0.75 hp (0.56 kW) power output
Industrial rating at 150% overload for 1 minute
- 180-240V AC single-phase input, 50/60 Hz
- Single-phase rectifier bridge
- 3-phase, short circuit rated, ultrafast IGBT inverter
- HEXFRED ultrafast soft recovery freewheeling diodes
- Low inductance (current sense) shunts in positive and negative DC rail
- NTC temperature sensor
- Pin-to-baseplate isolation 2500V rms
- Easy-to-mount two-screw package
- Case temperature range -25°C to 125°C operational



Figure 1. IRPT1058A Power Module

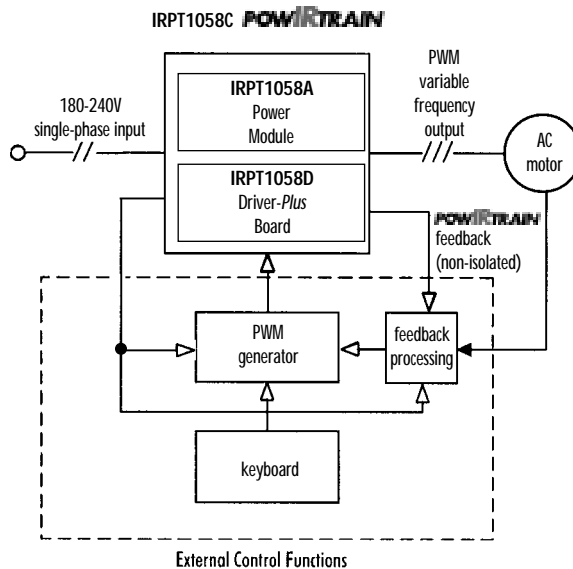

Figure 2. The IRPT1058C POWIRTRAIN within a motor control system

The IRPT1058A Power Module

The IRPT1058A Power Module, shown in figure 1, is a chip and wire epoxy encapsulated module. It houses input rectifiers, output inverter, current sense shunts and NTC thermistor. The single-phase input bridge rectifiers are rated at 800V. The inverter section employs 600V, short circuit rated, ultrafast IGBTs and ultrafast freewheeling diodes. Current sensing is achieved through 75 mΩ low inductance shunts provided in the positive and negative DC bus rail. The NTC thermistor provides temperature sensing capability. The lead spacing on the power module meets UL840 pollution level 3 requirements.

The power circuit and layout within the module are carefully designed to minimize inductance in the power path, to reduce noise during inverter operation and to improve the inverter efficiency. The Driver-Plus Board required to run the inverter can be soldered to the power module pins, thus minimizing assembly and alignment. The power module is designed to be mounted to a heat sink with two screw mount positions, in order to insure good thermal contact between the module substrate and the heat sink.

POWERTRAIN

The IRPT1058A **POWERTRAIN** (Figure 3) provides the complete power conversion function for a 0.75 hp (0.56 kW) variable voltage, variable frequency AC motor controller. The **POWERTRAIN** combines the Power Module (IRPT1058A) with a Driver-Plus Board (IRPT1058D).

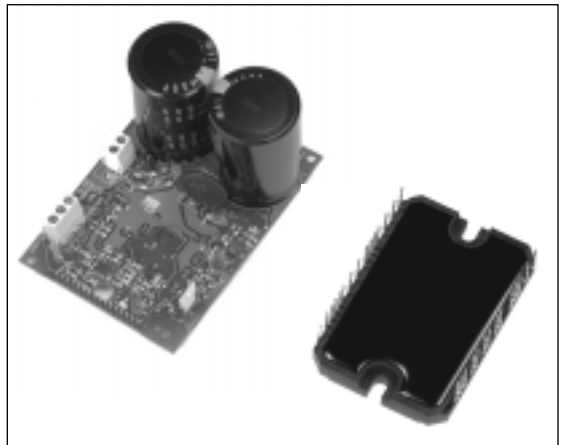

Figure 3. IRPT1058C **POWERTRAIN**

Specifications

PARAMETERS	VALUES	CONDITIONS
<i>Input Power</i>		
Voltage	220V AC, -15%, +10%, single-phase	
Frequency	50/60 Hz	
Current	7.6A rms @ nominal output	$T_A = 40^\circ\text{C}$, $R_{thSA} = 1.69^\circ\text{C/W}$
I_{FSM}	150A	10ms half-cycle, non-repetitive surge
<i>Output Power</i>		
Voltage	0 - 230V rms	defined by external PWM control
Nominal motor hp (kW)	0.75 hp (0.56 kW) nominal full load power 150% overload for 1 minute	$V_{in} = 220\text{V}$, $f_{pwm} = 4\text{ kHz}$, $f_o = 60\text{ Hz}$, $T_A = 40^\circ\text{C}$, $R_{thSA} = 1.69^\circ\text{C/W}$
Nominal motor current	3.3A nominal full load power 4.95A 150% overload for 1 minute	
<i>DC Link</i>		
DC link voltage	425V maximum	
<i>Sensor</i>		
Temp. sense resistance	50 kOhms $\pm 5\%$ 3.1kOhms $\pm 10\%$	@ $T_{NTC} = 25^\circ\text{C}$ @ $T_{NTC} = 100^\circ\text{C}$
Current sense	75mOhms $\pm 5\%$	@ $T_{SHUNT} = 25^\circ\text{C}$
<i>Protection</i>		
IGBT short circuit time	10 μs	DC bus = 425V, $V_{GE} = 15\text{V}$, line to line short
Recommended short circuit-shutdown current	18A peak	
<i>Gate Drive</i>		
Q_G	34 nC (typical)	@ $V_{GE} = 15\text{V}$, refer Figure 5b
Recommended gate driver	IR2132J (see Figure 10)	
<i>Module</i>		
Isolation voltage	2500V rms	pin-to-baseplate, 60 Hz, 1 minute
Operating case temperature	-25°C to 125°C	95% RH max. (non-condensing)
Mounting torque	1 Nm	M4 screw type
Storage temperature range	-40°C to 125°C	
Soldering temperature for 10 sec.	260°C maximum	at the pins (.06" from case)

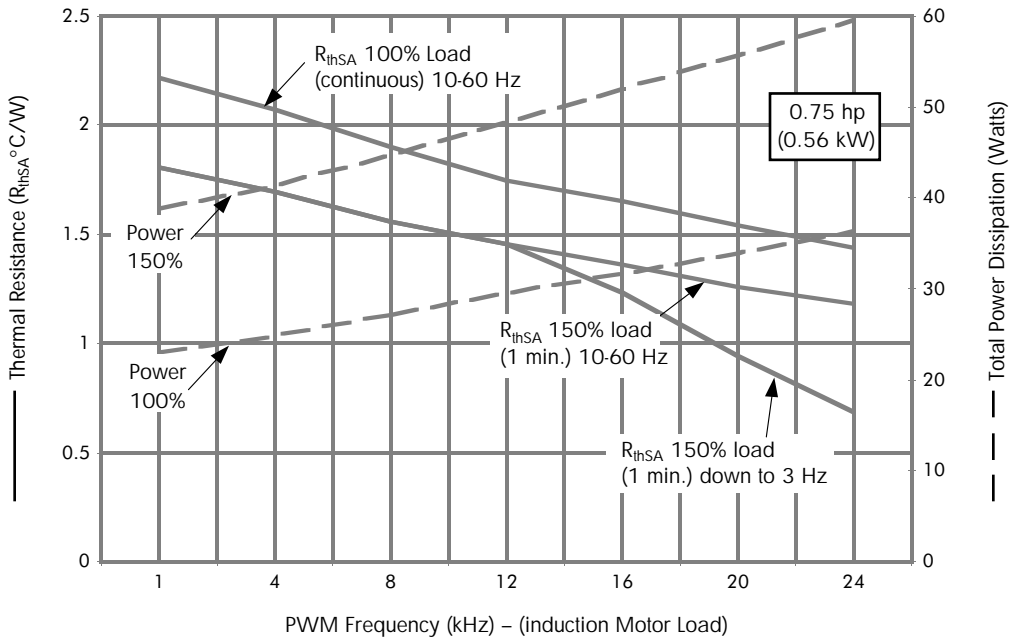

Figure 4a. 0.75 hp/3.3A Output Heat Sink Thermal Resistance and Power Dissipation vs. PWM Frequency

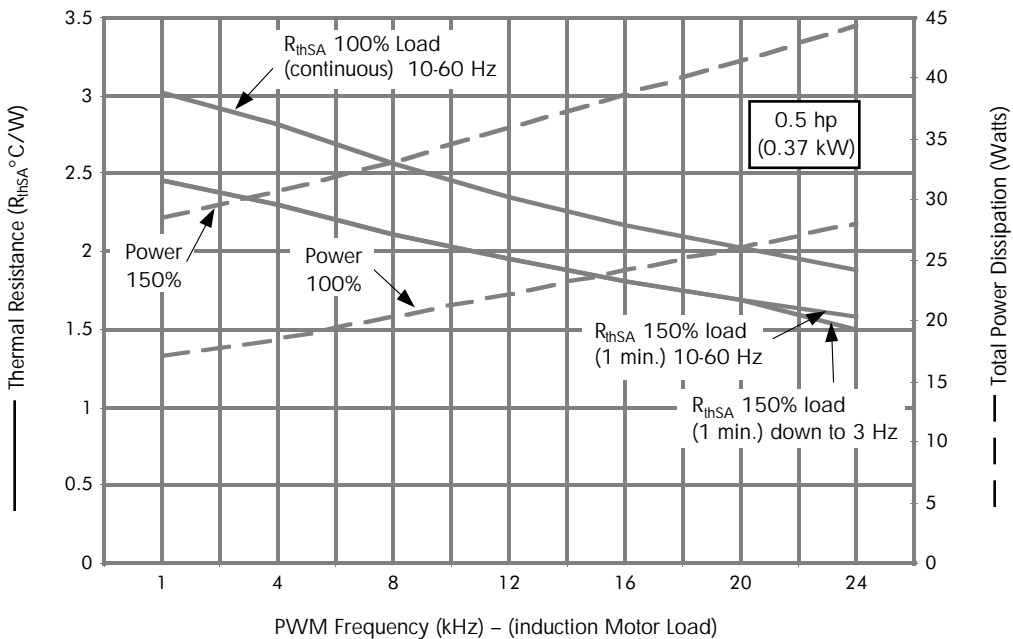

Figure 4b. 0.5 hp/2.2A Output Heat Sink Thermal Resistance and Power Dissipation vs. PWM Frequency

NOTE: For Figures 4a and 4b: Operating Conditions: $V_{in} = 230V_{rms}$, $MI = 1.15$, $PF = 0.8$, $T_A = 40^\circ C$, Z_{thSA} limits ΔT_c rise during 1 minute overload to $10^\circ C$

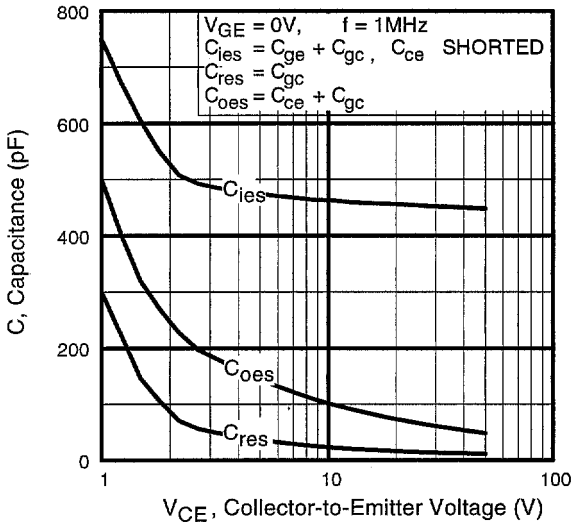

Figure 5a. Typical Capacitance vs Collector-to-Emitter Voltage

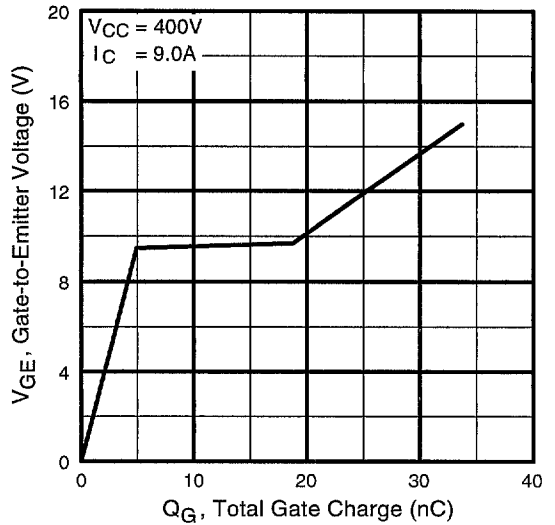

Figure 5b. Typical Gate Charge vs Gate-to-Emitter Voltage

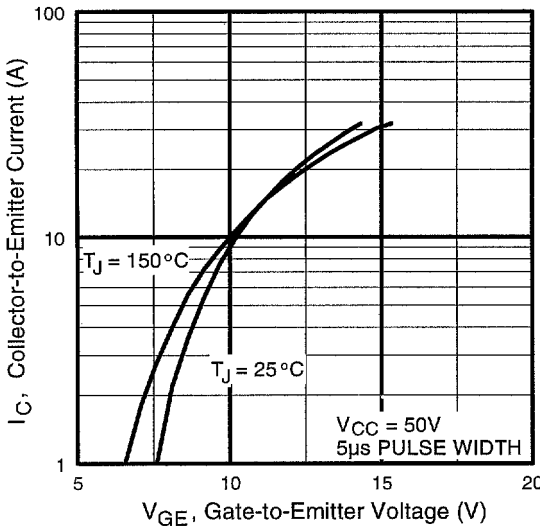

Figure 5c. Typical Transfer Characteristics

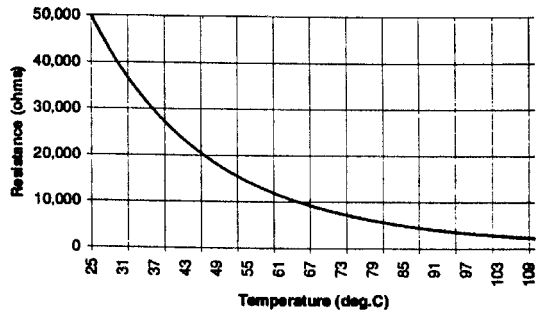

Figure 6. Nominal R-T Characteristics of the NTC Thermistor

Mounting Procedure

Mounting

1. Connect the driver board and the IRPT1058A power module.
2. Remove all particles and grit from the heat sink and power substrate.
3. Spread a .004" to .005" layer of silicone grease on the heat sink, covering the entire area that the power substrate will occupy. Recommended heat sink flatness is .001 inch/inch and Total Indicator Readout (TIR) of .003 inch below substrate.
4. Place the power substrate onto the heat sink with the mounting holes aligned and press it firmly into the silicone grease.
5. Place the 2 M4 mounting screws through the PCB and power module and into the heat sink and tighten the screws to 1 Nm torque.

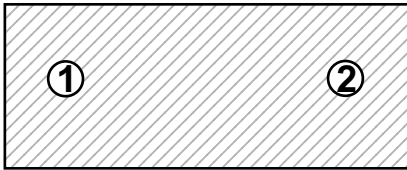

Figure 7. Power Module Mounting Screw Sequence

Power Connections

The power module pin designation, function and other details can be obtained from the package outline Figure 8 and circuit diagram Figure 9. Single-phase input connections are made to pins R and S and inverter output connections made to pins U, V and W. Positive rectifier output and positive inverter bus are brought out to pins RP and P respectively in order to provide DC bus capacitor soft charging implementation option. The current shunt terminals are connected to pins IS1, IS2 and IS3, IS4 on the positive and negative DC rails respectively.

Functional Information

Heat Sink Requirements

Figures 4a-4b show the thermal resistance of the heat sink required for various output power levels and Pulse-Width-Modulated (PWM) switching frequencies. Maximum total losses of the unit are also shown. This data is based on the following key operating conditions:

- The maximum continuous combined losses of the rectifier and inverter occur at full pulse-width-modulation. These maximum losses set the maximum continuous operating temperature of the heat sink.
- The maximum combined losses of the rectifier and inverter at full pulse-width-modulation under overload set the incremental temperature rise of the heat sink during overload.
- The minimum output frequency at which full load current is to be delivered sets the peak IGBT junction temperature.
- At low output frequency, IGBT junction temperature tends to follow the instantaneous fluctuations of the output current. Thus, peak junction temperature rise increases as output frequency decreases.

Over-Temperature Protection

Over-temperature can be detected using the NTC thermistor included in the power module for thermal sensing. Protection circuit that initiates a shutdown if the temperature of the IMS substrate exceeds a set level can be implemented. The nominal resistance vs. temperature characteristic of the thermistor is given in Figure 6.

Voltage Rise During Braking

The motor will feed energy back to the DC link during regenerative braking, forcing the bus voltage to rise above the level defined by the input line voltage. Deceleration of the motor must be controlled by appropriate PWM control to keep the DC bus voltage within the rated maximum value.

IRPT1058A Mechanical Specifications

NOTE: Dimensions are in inches (millimeters)

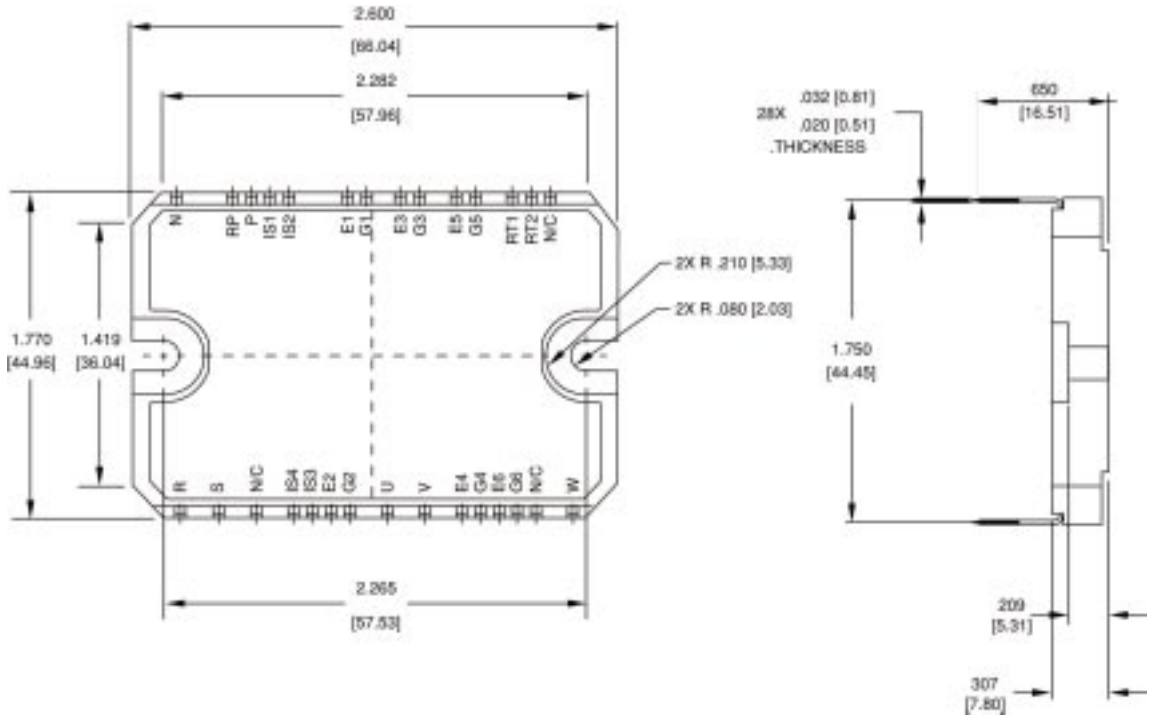

Figure 8a. Package Outline and Mechanical Specifications

IRPT1058A Mechanical Specifications

NOTE: Dimensions are in inches (millimeters)

ALL PIN COORDINATE DIMENSIONS ARE BASIC

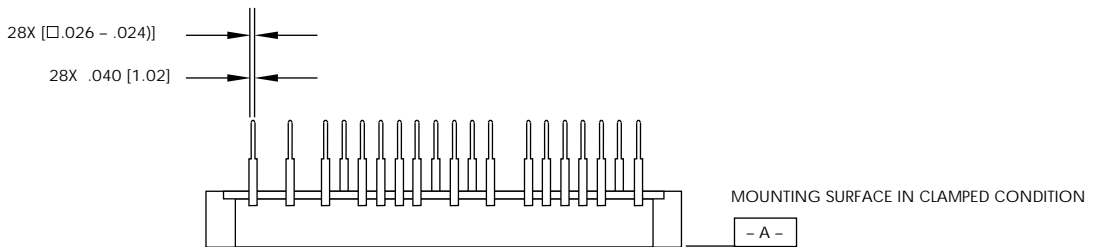
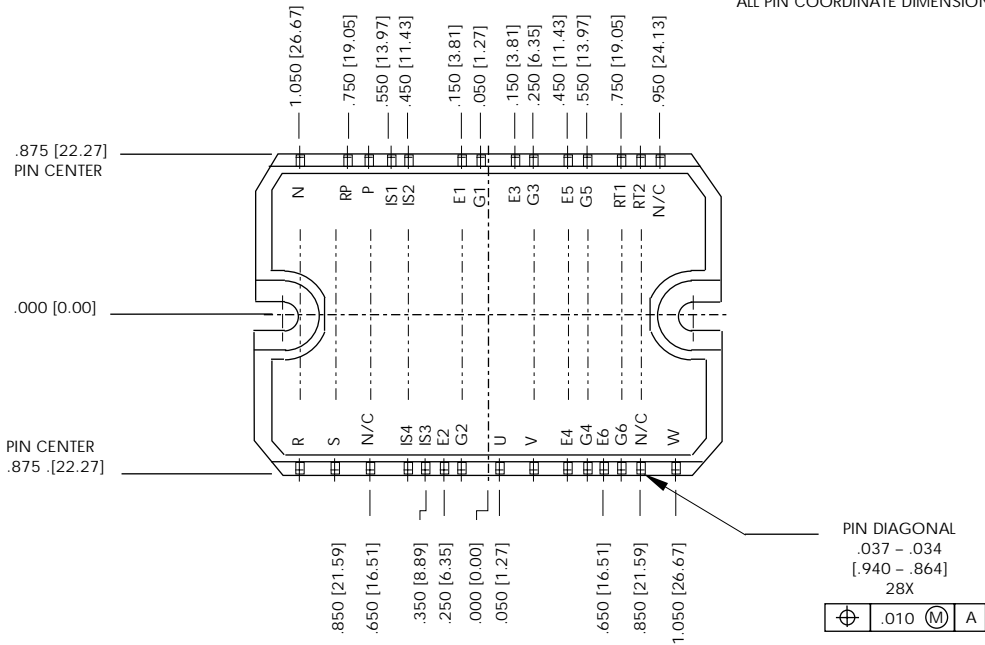

Figure 8b. Package Outline and Mechanical Specifications

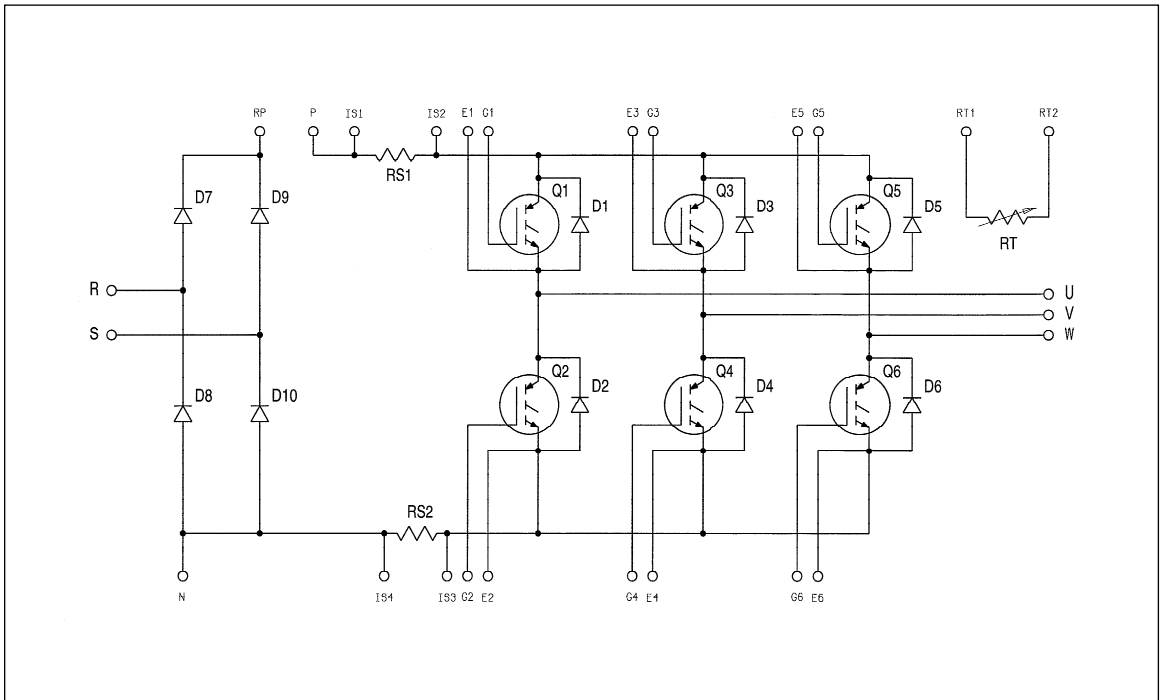

Figure 9. Power Module Circuit Diagram

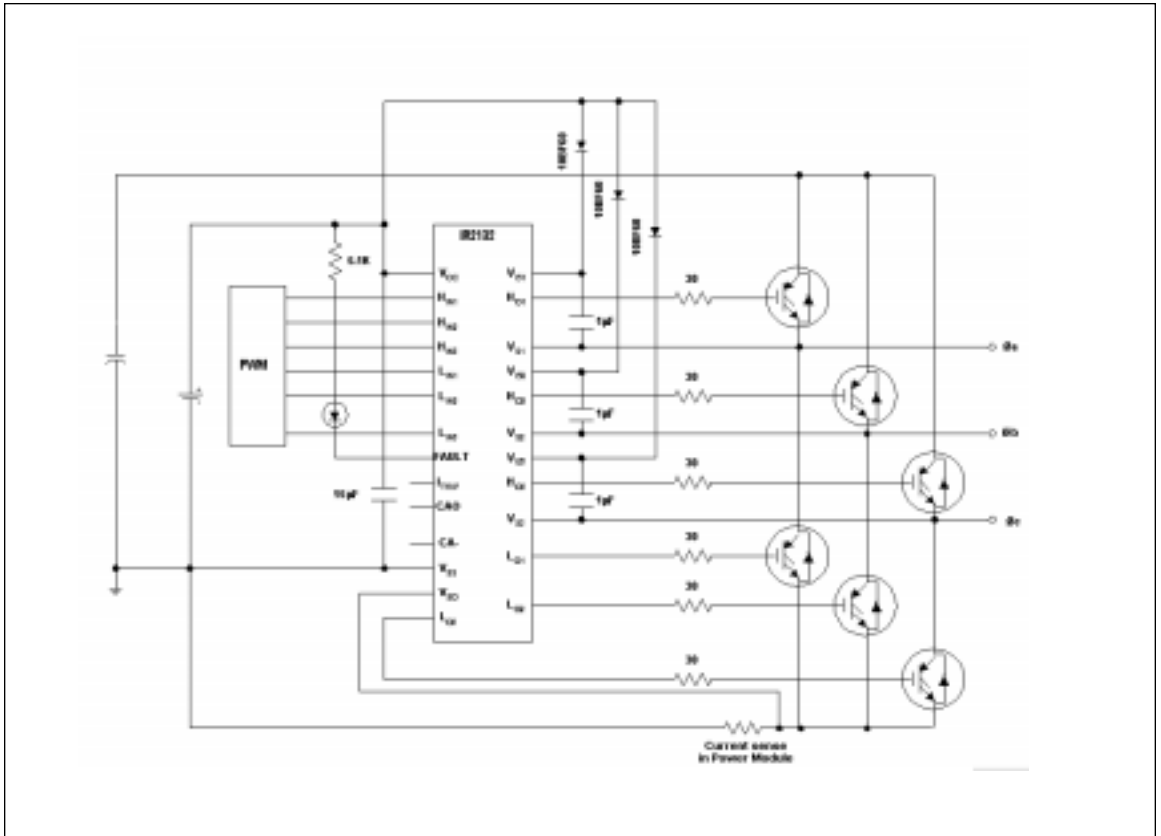

Figure 10. Recommended Gate Drive Circuit

Part Number Identification and Ordering Instructions

IRPT1058A Power Module

Chip and wire epoxy encapsulated module with 800V rectifiers, 600V short-circuit rated, ultra-fast IGBT inverter with ultra-fast freewheeling diodes, temperature sensing NTC thermistor and current-sensing low-inductance shunts.

IRPT1058C **POWERTRAIN**

Integrated Power Module (IRPT1058A) and Driver-*Plus* Board (IRPT1058D) pre-assembled and tested to meet all system specifications.

IRPT1058D Driver-*Plus* Board

Printed circuit board assembled with DC link capacitors, NTC in-rush limiting thermistor, high-power terminal blocks, surge suppression MOV, IGBT gate drivers, protection circuitry and low power supply. The PCB is functionally tested with standard power module to meet all system specifications.

International
IOR Rectifier

WORLD HEADQUARTERS: 233 Kansas St., El Segundo, California 90245, Tel: (310) 322 3331

EUROPEAN HEADQUARTERS: Hurst Green, Oxted, Surrey RH8 9BB, UK Tel: ++ 44 1883 732020

IR CANADA: 7321 Victoria Park Ave., Suite 201, Markham, Ontario L3R 2Z8, Tel: (905) 475 1897

IR GERMANY: Saalburgstrasse 157, 61350 Bad Homburg Tel: ++ 49 6172 96590

IR ITALY: Via Liguria 49, 10071 Borgaro, Torino Tel: ++ 39 11 451 0111

IR FAR EAST: 171 (K&H Bldg.), 3-30-4 Nishi-ikebukuro 3-Chome, Toshima-ku, Tokyo Japan Tel: 81 3 3983 0086

IR SOUTHEAST ASIA: 315 Outram Road, #10-02 Tan Boon Liat Building, Singapore 0316 Tel: 65 221 8371

<http://www.irf.com/> Data and specifications subject to change without notice. 9/97